

DATASHEET

CATEGORY: KIT ATCONTROL
 NAME: **KIT ATCONTROL/B PT-M 20**
 REFERENCE: **AT-8726**

PRODUCT DESCRIPTION

KIT ATCONTROL/B PT-M 20 - Kit with Single-phase protector against permanent and transient overvoltages, shunt release and MCB with nominal current $I_n = 20A$. Actuating time $275V \rightarrow 3-5s$ / $400V \rightarrow 0,1-0,2s$. $I_{max}(8/20) = 15kA$. $U_p = 1,1kV$.



KIT ATCONTROL protectors cut off the power supply when they detect a permanent overvoltage , (for example, a fault in the neutral), thus protecting the equipment installed downstream.

Moreover, they also actuate when they detect a transient overvoltage, driving the current to earth and reducing the voltage to a level that does not damage the connected equipment. Tested and certified as protector Type 2 in official and independent laboratories according to standard EN IEC 61643-11.

It has a test button to check that installation has been executed correctly.

This protector is self-configurable. It automatically detects the voltage and programmes the permanent overvoltage limits.

DATASHEET

Reference	AT-8726
-----------	---------

> DIMENSIONS

Protector dimensions	36 x 90 x 80 mm
Number of DIN modules (DIN 43880) of the protector	2
Element 1	Circuit breaker + shunt release
Dimensions of the element 1	51 x 81 x 65 mm
Number of DIN modules (DIN 43880) of the element 1	3

> ELECTRICALS

Nominal current	20 A
Type of line	Single-phase
Maximum short-circuit current	6 kA
Nominal voltage for the shunt release	110-415 VAC / 110-250 VDC

- Configuration A

Nominal voltage (L-N)	U_n	230 V
-----------------------	-------	-------

Maximum overvoltage (L-N)	U_c	400 V
Actuation voltage V1 (L-N)	U_a	275 V
Actuation time at V1		3-5 s
Actuation voltage V2 (L-N)		400 V
Actuation time (V2)		0,1-0,2 s

- Configuration B

Nominal voltage (L-N)	U_n	120 V
Maximum overvoltage (L-N)	U_c	400 V
Actuation voltage V1 (L-N)	U_a	150 V
Actuation time at V1		3-5 s
Actuation voltage V2 (L-N)		230 V
Actuation time at V2		0,1-0,2 s

- Protection against transient overvoltages

Test type according to UNE-EN61643-11		Type 2
Protection categories according to the REBT		I, II, III, IV
Nominal discharge current (8/20 μ s wave)	I_n	5 kA
Maximum discharge current (8/20 μ s wave)	I_{max}	15 kA
Protection level at $I_n(1,2/50 \mu$ s wave)	U_p	1.1 kV

> CONSTRUCTION

Type of connection	Parallel (one port)
Fixing	DIN Rail
Enclosure material	Polyamide
Insulation resistance	$> 10^{14} \Omega$
Self-extinguishing enclosure	V-0 Type according to UNE-EN IEC 60707 (UL94)
Nr. of poles	2
Warning for permanent overvoltages	Warning light. Green light: correct mains voltage. Red: overvoltage
Warning for transient overvoltages	Warning mechanism. Yellow: protector status ok. Black: Replace

> ENVIRONMENTAL

Working temperature	-5 to +40 °C
Protector location	Indoor
Enclosure protection	IP20

> CONNECTION

- Protector cables

Minimum / Maximum section	2,5 / 35 mm ²
---------------------------	--------------------------

Screw	Philips, H2
Tightening	3 N·m

- Activation cables (S1, S2)

Minimum / Maximum section	1 / 1,5 mm ²
Screw	DIN 5264, M 2
Tightening	0.25 N·m

- Cables of element 1

Cables of element 1	Circuit breaker
Minimum / Maximum section	4 / 25 mm ²
Screw	Philips, H2
Tightening	3 N·m

- Cables of element 2

Cables of element 2	Shunt release
Minimum / Maximum section	1 / 4 mm ²
Screw	Philips, H1
Tightening	1.2 N·m

> TESTS AND CERTIFICATIONS

Certificated tests according to the standard: UNE-EN IEC 61643-11

UNE-EN IEC 60898

UNE-EN 50550 (POP)

Relevant standards: UNE 21186, UNE-EN IEC 62305

Products compliant with EC requirements.

INSTRUCTIONS

> INSTALLATION

They must be installed in parallel with the low voltage supply line, downstream from the circuit breaker included in the kit.

The circuit breaker must be installed in series with the low voltage line, between the power control breaker (ICP) and the residual current breaker (ID).

Connect the S1 and S2 terminals, always without voltage, to the shunt release included in the kit.

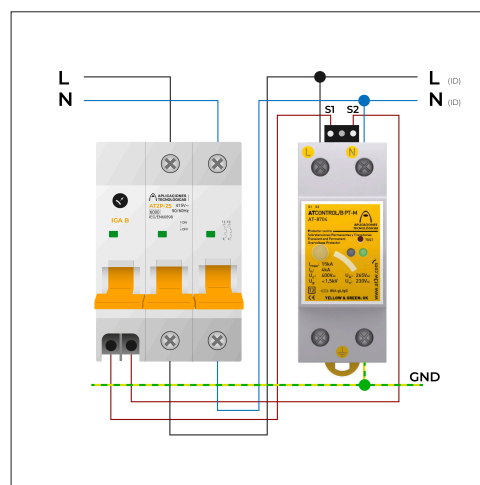

> SAFETY AND MAINTENANCE

Installation should be carried out without power in the line and can only be done by authorized professionals.

Connection to earth is a must.

OTHER INFORMATION

> OTHER REFERENCES

AT-8711: KIT ATCONTROL/B PT-M 25

AT-8712: KIT ATCONTROL/B PT-M 32

AT-8713: KIT ATCONTROL/B PT-M 40

AT-8714: KIT ATCONTROL/B PT-M 50

AT-8715: KIT ATCONTROL/B PT-M 63

AT-8723: KIT ATCONTROL/B PT-M 6

AT-8724: KIT ATCONTROL/B PT-M 10

AT-8725: KIT ATCONTROL/B PT-M 16